

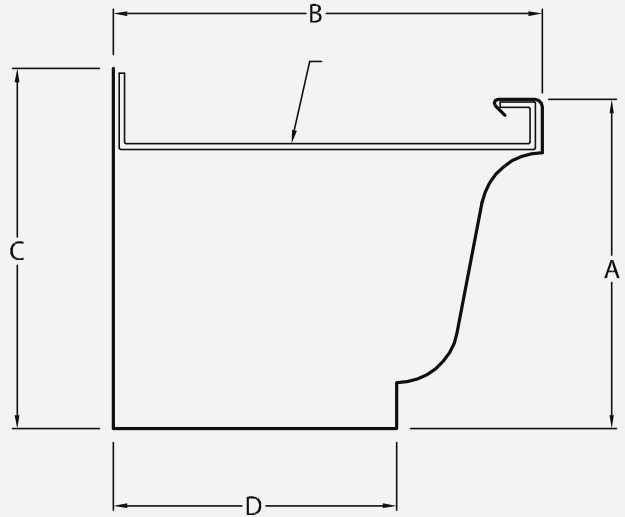

K-Style Gutter + Accessories

ORDER SPECIFICATION FORM

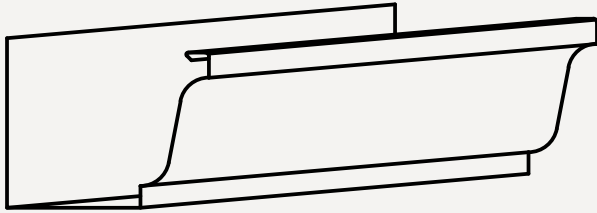

| SIZE | A | B | C | D |
|------|-----------------------------------|-----|-----------------------------------|---------------------------------|
| 5" | 3 ¹³ / ₃₂ " | 5" | 5 ¹³ / ₁₆ " | 3 ¹ / ₄ " |
| 6" | 4 ¹ / ₂ " | 6" | 5" | 3 ⁷ / ₈ " |
| 7" | 5 ³ / ₈ " | 7" | 5 ⁷ / ₈ " | 4 ⁵ / ₈ " |
| 8" | 6" | 8" | 6 ¹ / ₈ " | 5 ³ / ₈ " |
| 9" | 7 ¹ / ₂ " | 9" | 8" | 6 ³ / ₄ " |
| 10" | 8 ¹ / ₂ " | 10" | 9" | 7 ³ / ₄ " |
| 11" | 9 ¹ / ₂ " | 11" | 10" | 8 ³ / ₄ " |

NOTES

① Subject to minimum requirements
 ② Custom lengths available

COMMENTS:

| MATERIAL | |
|--|---------------|
| 22 GA STEEL | .032 ALUMINUM |
| 24 GA STEEL | .040 ALUMINUM |
| 26 GA STEEL limited color availability | .050 ALUMINUM |
| 22 GA STAINLESS STEEL | 160Z COPPER |
| 24 GA STAINLESS STEEL | 200Z COPPER |
| 26 GA STAINLESS STEEL | |

COLOR

Select Metal Vendor _____ Select Color _____

QUANTITIES

_____ LINEAL FEET @ 10'-0" LENGTHS ②

_____ LINEAL FEET @ 20'-0" LENGTHS ① ②

_____ OUTSIDE MITERS @ 90°

_____ INSIDE MITERS @ 90°

_____ ENDCAPS: RIGHT _____ LEFT _____

_____ SPLICE PLATES

_____ EXPANSION JOINTS

_____ HIDDEN HANGERS

| PRINT APPROVED BY | PROJECT INFORMATION |
|--|------------------------------------|
| (SIGNATURE) _____ (DATE) _____ | (PROJECT NAME) _____ |
| | (ARCHITECT) _____ |
| A SIGNED PRINT APPROVAL SIGNIFIES A CUSTOMER HAS VERIFIED ALL DIMENSIONS, SIZES, QUANTITIES, AND MATERIAL TYPES. FABRICATION WILL PROCEED ONLY AFTER RECEIPT OF SIGNED PRINT APPROVAL. | (CUSTOMER) _____ |
| | (REPRESENTATIVE/DISTRIBUTOR) _____ |





K-Style Gutter + Accessories

ACCESSORIES

STAMPED HIDDEN HANGERS

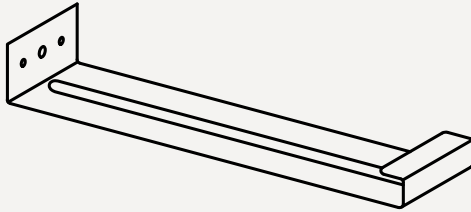

GUTTER SUPPORT BRACKETS

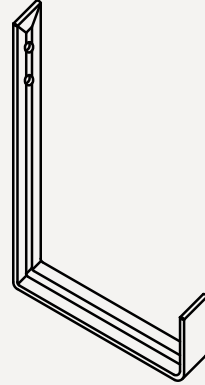

SPLICE PLATES

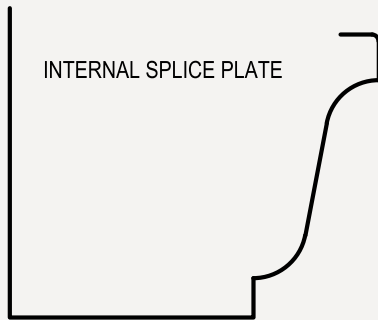
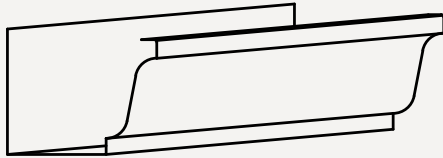

END CAPS

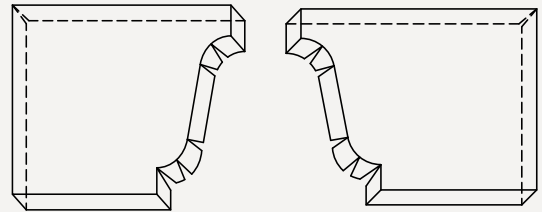

EdgeSystems

4 COMMERCE WAY, ARDEN NC 28704 USA
800-892-9173 828-676-1700 OMGEDGESYSTEMS.COM

Copyright © 2019 OMG, Inc. All rights reserved.

Superior productivity.
Superior performance.

