

TremLock Drip Edge Fascia

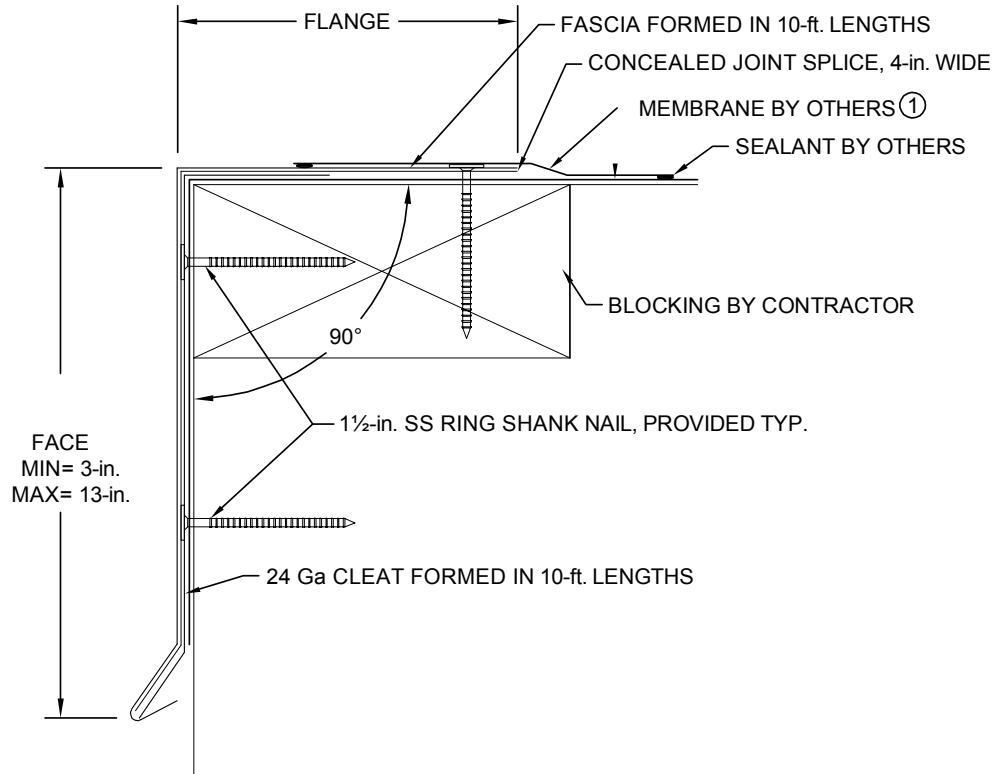

Order Specification Form



① Coordinate installation with membrane manufacturer.

QUANTITY	CAP MATERIAL	THICKNESS	COLOR	CAP FINISH
___ Total LF	<input type="checkbox"/> Aluminum	<input type="checkbox"/> 0.032	<input type="checkbox"/> Statuary Bronze (A-01)	<input type="checkbox"/> Mill Finish
___ Miters (___Outside, ___Inside)	<input type="checkbox"/> Galvanized	<input type="checkbox"/> 0.040	<input type="checkbox"/> Bone White (A-23)	<input type="checkbox"/> Prefinished Kynar
___ End Caps (___Left, ___Right)	<input type="checkbox"/> Stainless Steel	<input type="checkbox"/> 0.050	<input type="checkbox"/> Concord Cream (A-02)	<input type="checkbox"/> Post Finished Kynar
___ End Terms (___Left, ___Right)	<input type="checkbox"/> _____	<input type="checkbox"/> 0.063	<input type="checkbox"/> Medium Bronze (A-05)	<input type="checkbox"/> Prefinished Anodized
___ Radius LF	ACCESSORY TYPE	<input type="checkbox"/> 0.080	<input type="checkbox"/> Sandstone (A-06)	<input type="checkbox"/> Post Finished Anodized
	<input type="checkbox"/> Welded	<input type="checkbox"/> 24GA	<input type="checkbox"/> Dove Gray (A-09)	<input type="checkbox"/> _____
	<input type="checkbox"/> Metal-Lok	<input type="checkbox"/> 22GA	<input type="checkbox"/> Sierra Tan (A-26)	
			<input type="checkbox"/> _____	

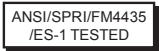
0.063 prefinished Kynar is only available in Statuary Bronze, Medium Bronze, Sandstone, Dove Gray, Ascot White, Forest Green & Bone White.
22 GA. prefinished Kynar is only available in Statuary Bronze, Medium Bronze, Shale Gray, Forest Green & Bone White .

APPROVALS: Contact manufacturer for verification of test report data on your project.		CUSTOMER APPROVAL	
 		<input type="checkbox"/> Approved for Fabrication <input type="checkbox"/> Approved with Changes <input type="checkbox"/> Not Approved	
		_____ Authorized Customer Signature	
		_____ Title Date	
Job Name:	Job #:	By:	
Customer:	Project Location:	Date:	
Representative:	Architect:	Sheet of	

TremLock Drip Edge Fascia

STANDARD COLORS - Other Colors Available

Ascot White	Bone White	Dove Gray	SILVERSMITH	Shale Gray
Rocky Gray	Sandstone	Champagne	Titanium	Charcoal Gray
Concord Cream	Rawhide	Sierra Tan	Coppertone	Mission Red
Bright Red	Redwood	Boysenberry	Chocolate Brown	Antique Patina
Siam Blue	Slate Blue	Turquoise	Regal Blue	Statuary Bronze
Black	Hemlock Green	Patina Green	Forest Green	Hartford Green
	* Premium Colors			
Medium Bronze				

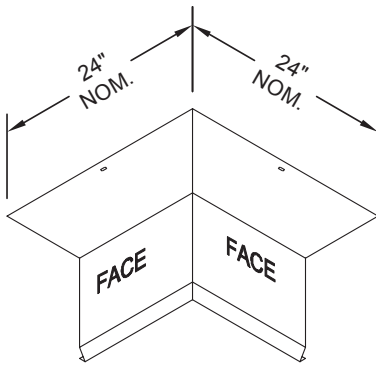
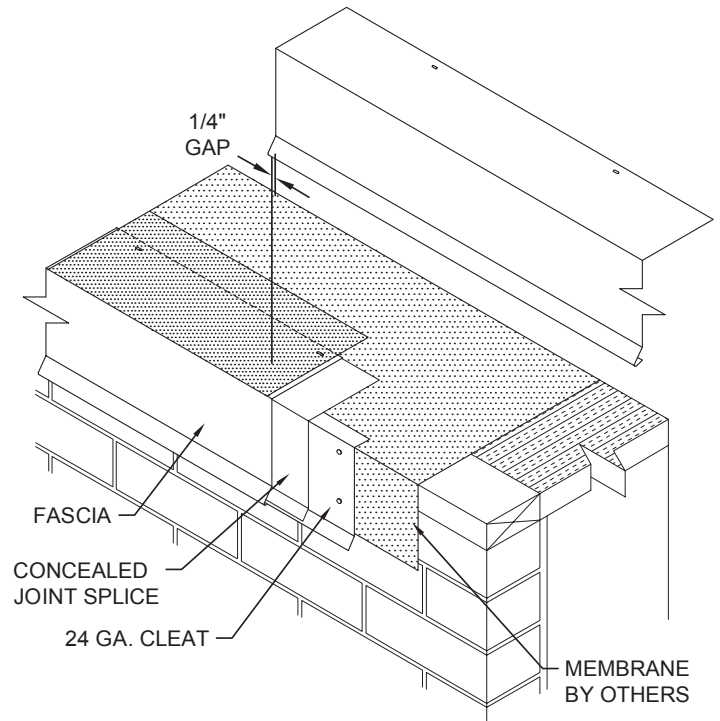

INSIDE MITER

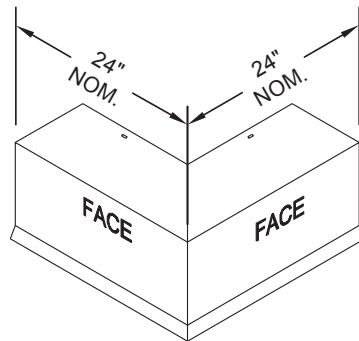

OUTSIDE MITER

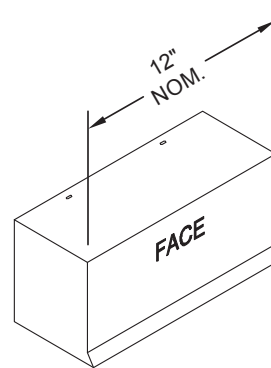

END CAP
LEFT HAND SHOWN

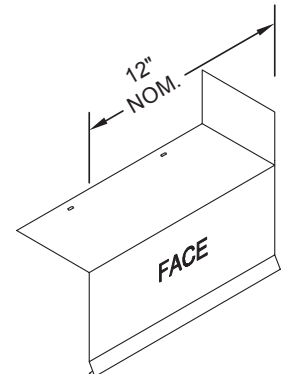

END TERM
RIGHT HAND SHOWN

Standard coping miter leg lengths are 24-in. Nominal
Standard fascia miter angle is 90°
For special miter requirements, attach sketches or consult manufacturer for assistance.